

99138

Dimensions

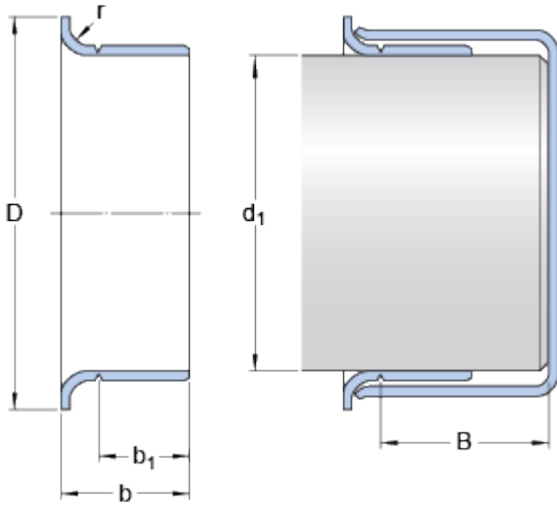

Nominal dimensions

d_1		34.925	mm
D		41.605	mm
Tolerance outside diameter D	\pm	1.6	mm
b		15.875	mm
Tolerance width b	\pm	0.8	mm
b_1		12.7	mm
Tolerance width b_1	\pm	0.8	mm
B	max.	20.65	mm
r	max.	3.18	mm

Shaft diameter range

d_1	min.	34.823	mm
d_1	max.	34.976	mm